

CITY CRANE MC 85 A

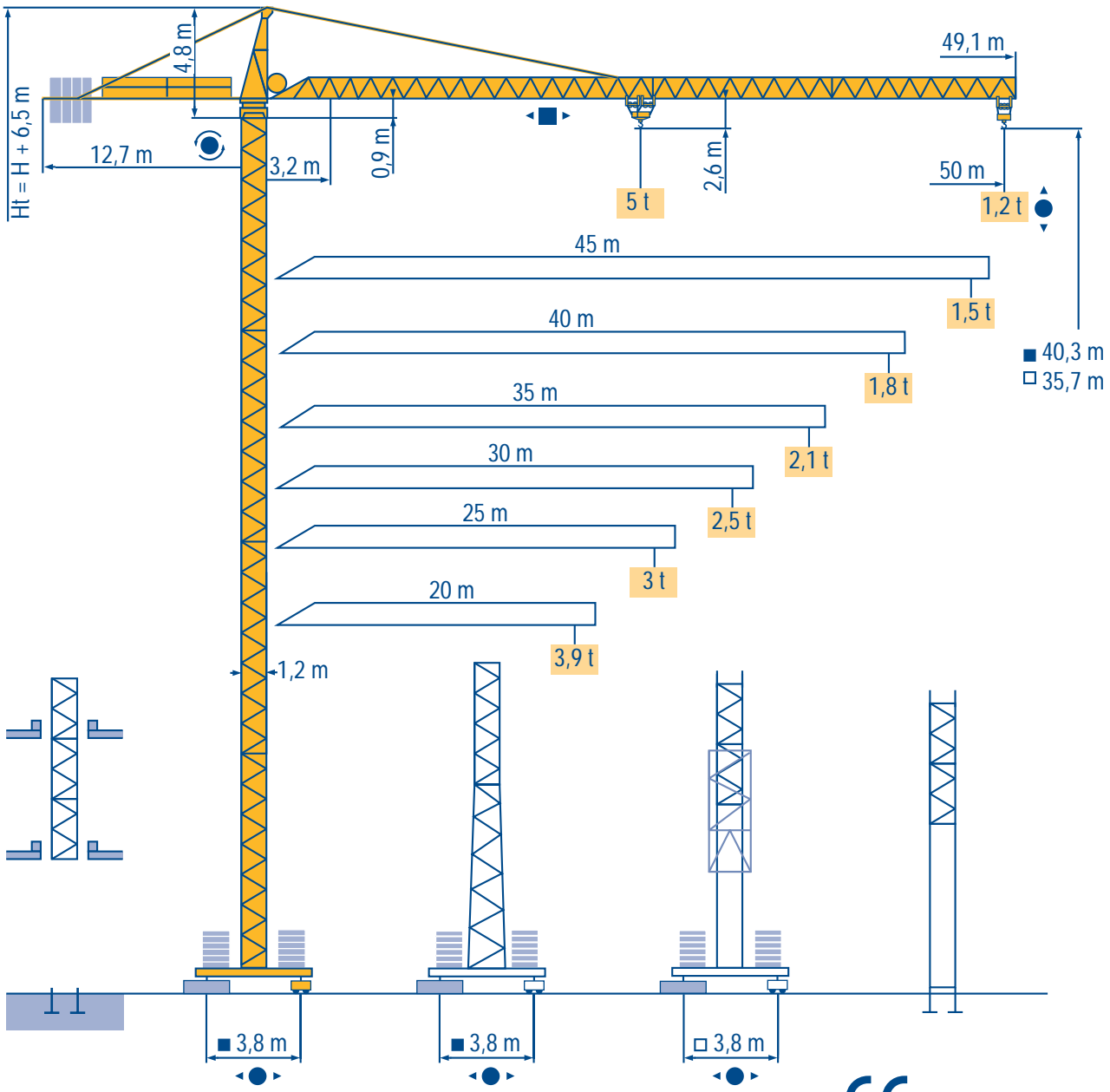

- HD
- HDT
- GTMR
- CITY CRANE
- TOPKIT MD
- MR
- MAXI MD
- MAXI TOPKIT

LOM 1

CE FEM 1.001-A3



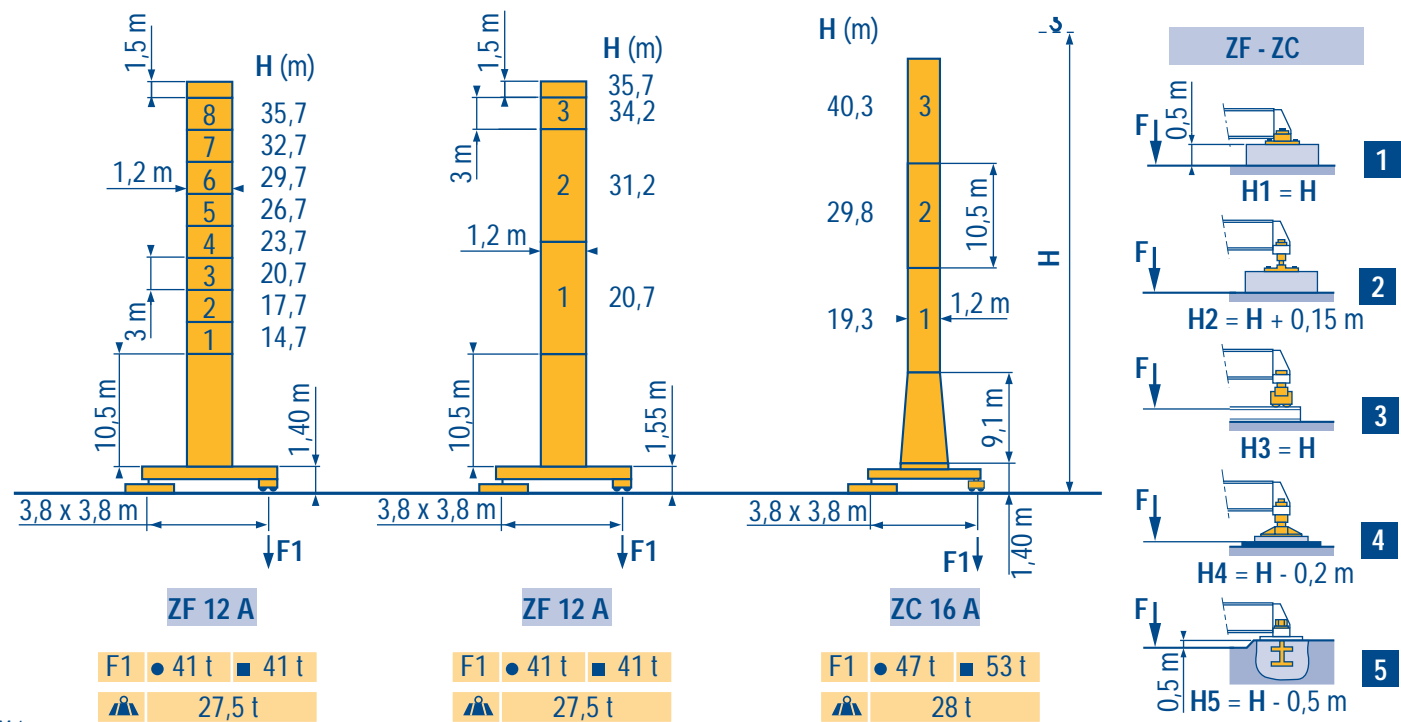
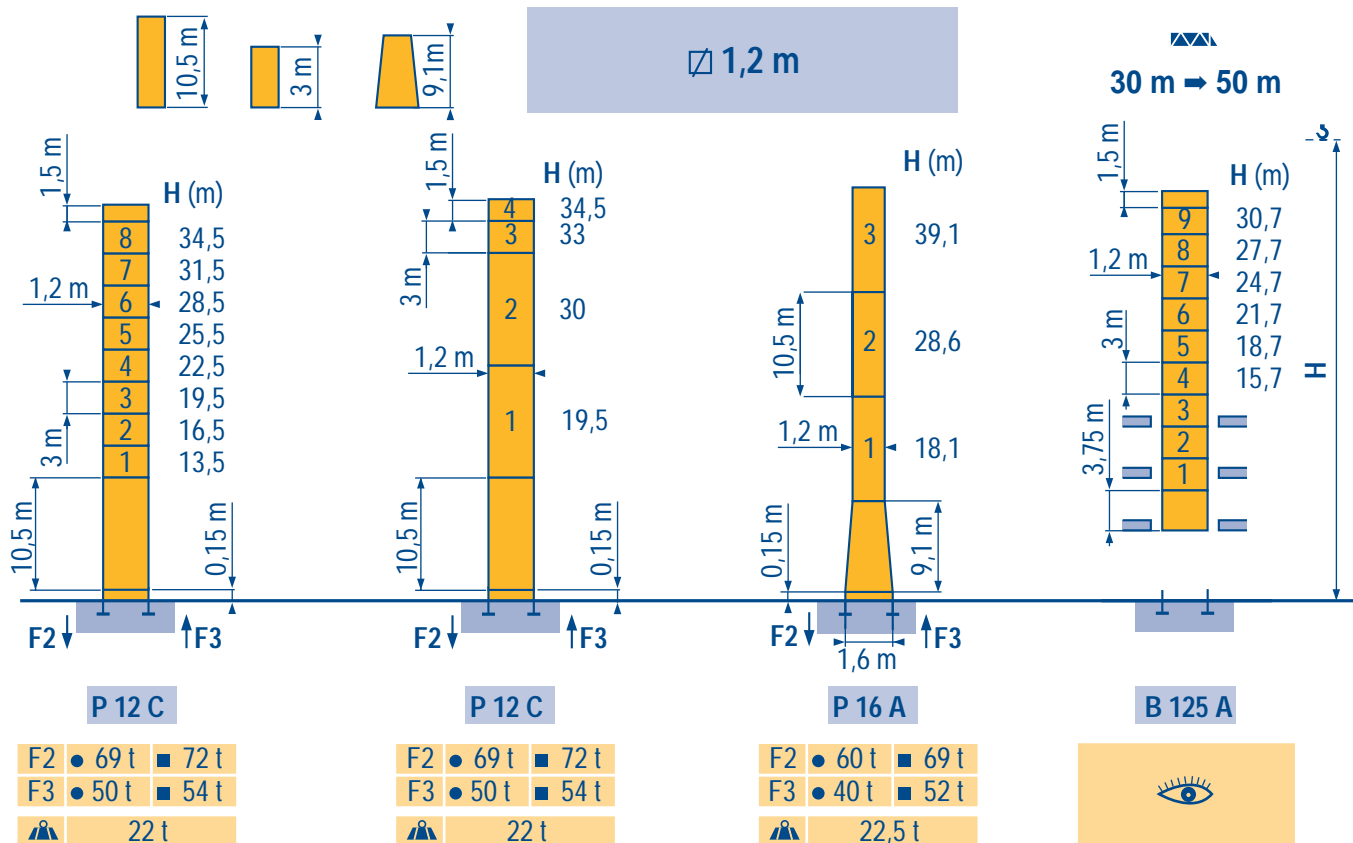

LOM 1

Voir télescopage sur dalles
 Réactions en service
 Réactions hors service
 A vide sans lest avec flèche et hauteur maximum.

See climbing crane
 Reactions in service
 Reactions out of service
 Without load and ballast with longest jib and maximum height.

Consultare gru in cavedio
 Reazioni in servizio
 Reazioni fuori servizio
 A vuoto senza zavorra e con braccio massimo e altezza massima.

Siehe Kletterkrane im Gebäude
 Reaktionskräfte in Betrieb
 Reaktionskräfte außer Betrieb
 Ohne Last und Ballast mit Maximalausleger und Maximalhöhe.

Vea grua trepadora
 Reacciones en servicio
 Reacciones fuera de servicio
 Sin carga, sin lastre con flecha y altura máxima.

见楼板顶升
 工作状态下的反应
 非工作状态下的反应
 空载, 无配重, 起重臂和高度均为最大值

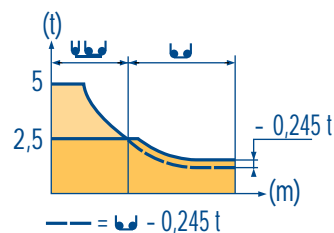
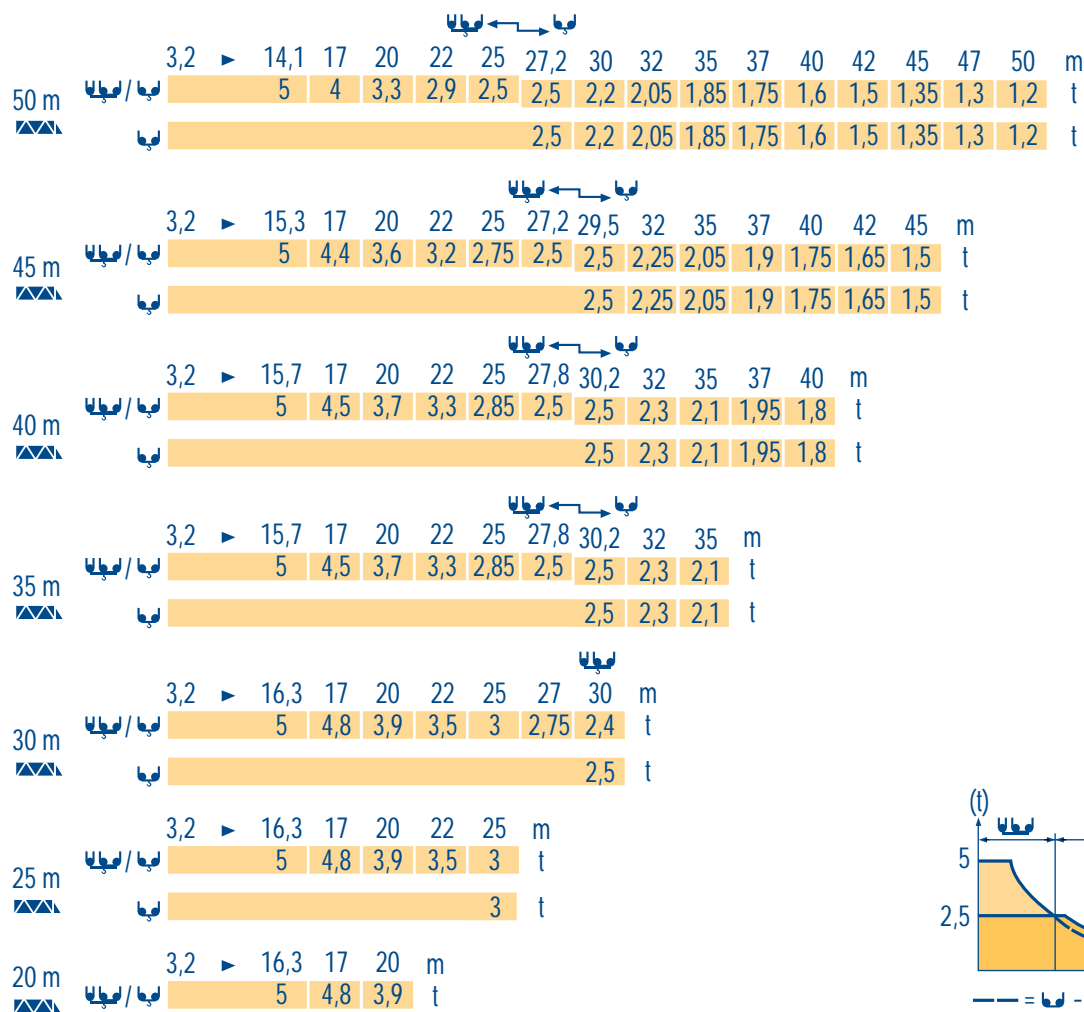

LOM 1

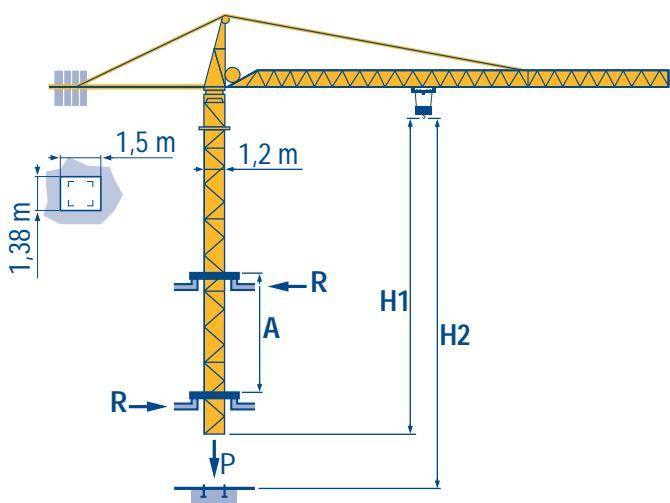

B 125 A

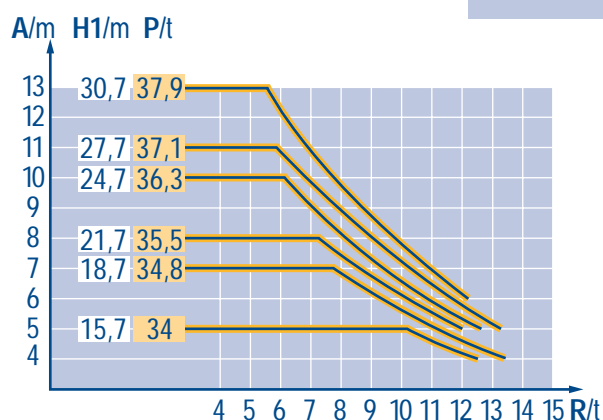

LOM 1

A Distance entre cadres
H1 Hauteur grue
P Poids de la grue (en service)
R Réaction horizontale

F Distance between collars
D Distancia entre marcos
Crane height
Crane weight (in service)
Horizontal reaction

GB Distanza fra i telai
E Altezza gru
Peso della gru (in servizio)
Reazione orizzontale

I
C

A Abstand zwischen den Rahmen
H1 Kranhöhe
P Krangewicht (in Betrieb)
R Horizontalkräfte

D Distancia entre marcos
E Altura grúa
Peso de la grúa (en servicio)
Reaccion horizontal

E 各附着框之间距离
工作状态 下塔机高度
工作状态 下塔机重量
水平反力

I
C

| | | F | | | GB | | | ch - PS hp | kW | | |
|--------|---------------|------------------------|--------------------|----------------------|-----|------|----------------|---------------|-------|---------|----------------|
| | | | | | | | | | | | |
| | 15 PC 13 | m/min | 7 | 21 | 42 | 3,5 | 10,5 | 21 | 15 | 11 | 185 m > 185 |
| | | t | 2,5 | 2,5 | 1,3 | 5 | 5 | 2,6 | | | |
| | 25 PC 13 | m/min | 6,6 | 33 | 66 | 3,3 | 16,5 | 33 | 25 | 18,5 | 322 m > 322 |
| | | t | 2,5 | 2,5 | 1,3 | 5 | 5 | 2,6 | | | |
| | 25 LVF 13 | m/min | 4 → 10,5 → 33 → 66 | 2 → 5,25 → 16,5 → 33 | 25 | 18,5 | 322 m > 322 | | | | |
| | | t | 2,5 | 2,5 | 2,5 | 1,3 | 5 | 5 | 5 | 2,6 | |
| | 3 D2 V5 | m/min | 21 - 42 | | | | | | 3 | 2,2 | |
| | 4 D3 V3 | m/min | 15 - 30 - 58 | | | | | | 4 | 3 | |
| | RCV 80 | tr/min U/min rpm | 0 → 0,8 | | | | | | 8 | 5 | |
| ZF | TVD 324 C1 | m/min | 26 | | | | | | 2 x 4 | 2 x 2,9 | |
| ZC | RT 224 | m/min | 25 | | | | | | 2 x 4 | 2 x 2,9 | |

| | | | |
|------------------------|--------|---|-----------------|
| CEI 38 | IEC 38 | kVA | |
| 400 V (+6% -10%) 50 Hz | | 15 PC : 25 kVA 25 PC - 25 LVF : 35 kVA | 84/534 - 87/405 |

LOM 1

| | | | | | | |
|--|--|----------|--|-----------|--|----------|
| | Levage | F | Hoisting | GB | Sollevamento | I |
| | Distribution | | Trolleying | | Distribuzione | |
| | Orientation | | Slewing | | Rotazione | |
| | Translation | | Travelling | | Traslazione | |
| | Conforme aux directives CEE 84/534 et 87/405 sur le niveau acoustique | | In compliance with the EEC 84/534 and 87/405 Instructions on noise level | | Conforme alle direttive CEE 84/534 e 87/405 sul livello acustico | |
| | Nous consulter | | Consult us | | Consultateci | |
| | Heben | D | Elevación | E | 起升 | C |
| | Katzfahren | | Distribución | | 变幅 | |
| | Schwenken | | Orientación | | 回转 | |
| | Kranfahren | | Traslación | | 行走 | |
| | Gemäss EWG-Richtlinien 84/534 und 87/405 für den Schall-Leistungspegel | | Conforme con las directivas CEE 84/534 y 87/405 sobre el nivel acustico | | 符合 CEE 84/534 - CEE 87/405 声晌度规定 | |
| | Auf Anfrage | | Consultarnos | | 请向我方咨询 | |

Réf. 1997.52 LOM 1



18.Rue de Charbonnières, B.P. 173-F
69132 ECULLY Cedex
Tél. (33)04.72.20.20.20
Fax (33)04.72.20.20.00
http://www.potain.fr
E-mail : mkt@potain.fr

CITY CRANE MC 85 A

Copyright.Reproduction interdite © POTAIN 1997

Deutschland
POTAIN GmbH Tel : 06.105.704.0
Italia
POTAIN S.p.A. Tel : 039.65.631
China
Zhangjiagang POTAIN Tel : 520. 877.1451